

HOSPITALITY SOLUTION

for new & existing hotels



www.inels.com/hotel





30
years
of innovations

ELKO EP have been your partner in the field for 30 years, developing and manufacturing the highest quality electronic devices for electroinstallation as well as Smart System for Residential and Building automation.

ELKO EP employs more than 350 people across 11 foreign branches and exports its products to more than seventy countries. Company of the Year, Visionary of the Year, Superbrands and Global Exporter of the Year are just some of the awards we have received throughout the years as we consistently strive to move forward in the field of innovation and development.

Millions of relays, thousands of smart homes, hundreds of buildings and many satisfied customers - This is ELKO EP; a traditional company based in the center of Europe, where own development, production, logistics, and service are at the forefront of our focus.

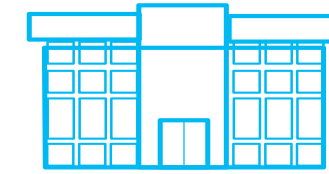

30 %

Czech

40 %

export

30 %

branches



WORLDWIDE

11 branches
6 franchises
70 export countries



350

employees
in holding



30 000 +

iNELS
installations



30 000 000 +

manufactured
products

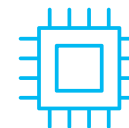

R&D

continuously
innovative



MANUFACTURER

fully automated
complete proces



SUPPORT

24 / 7 / 365

World leader
in DIN rail relays production

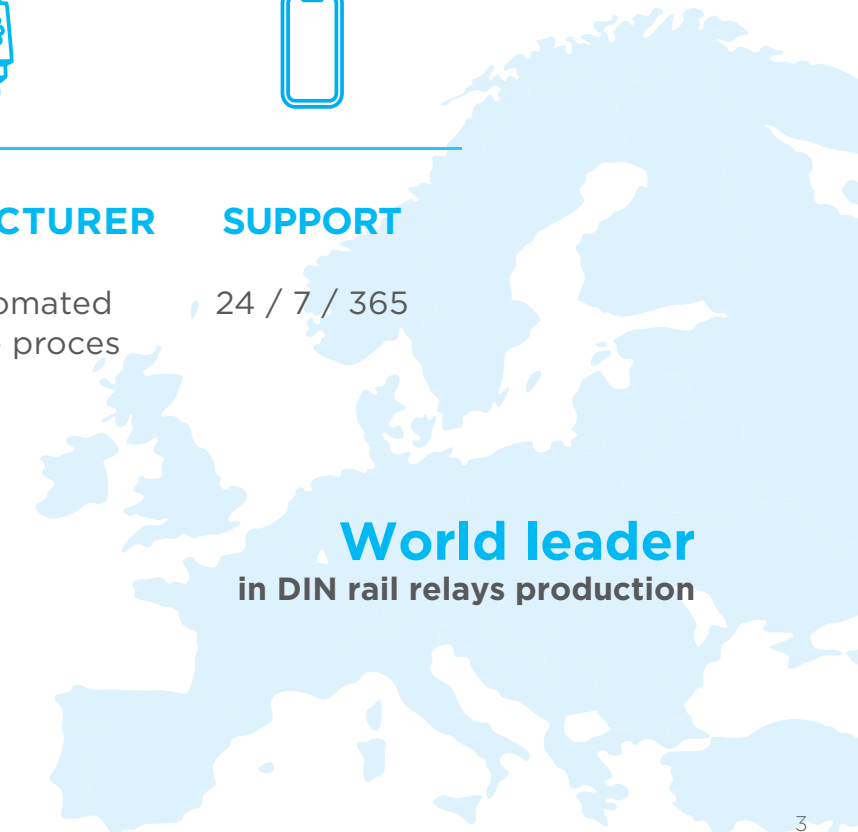

You'll feel right at home

ELKO EP develops and supplies the third generation iNELS Hospitality system - which means a system according to the latest trends and requirements for design and function. The iNELS GRMS bus system is designed for new hotel rooms and the iNELS HRESK wireless system for existing hotel rooms and retrofits.

Regardless of whether it is a new or existing room, the iNELS system offers unlimited possibilities to configure functions and devices in the hotel room. It is not only possible to customise the design of the controllers to the interior of the room, choosing plastic or natural frames from the wide range of Logus90 or directly selecting glass or metal controllers.

Savings

The occupancy presence function ensures that all the lights are switched off and the temperature is reduced to energy-saving mode. This can achieve unprecedented savings throughout the hotel.

Automation

Functions happen automatically in the background without disturbing the guest. An open window sensor blocks the thermostat, a PIR detector controls lighting and temperature.

Design

Whether you choose from the range of natural Logus frames, quality glass panels or luxurious metal buttons, you'll always have the option of colour combinations.

Customization

Thanks to direct source from the manufacturer, you can define colours, shapes, icons or button text, including your hotel logo. We can also prepare factory pre-programmed packages for plug and play use.

Integration

Cooperation with door locks and hotel reception software is a matter of course. Information about room occupancy, service or cleaning requests is exchanged. Everything happens automatically.

Versatility

iNELS Hospitality is suitable for all types of hotels, regardless of the number of stars. It can be conveniently expanded or changed at any time. The wireless and fieldbus systems interact with each other.

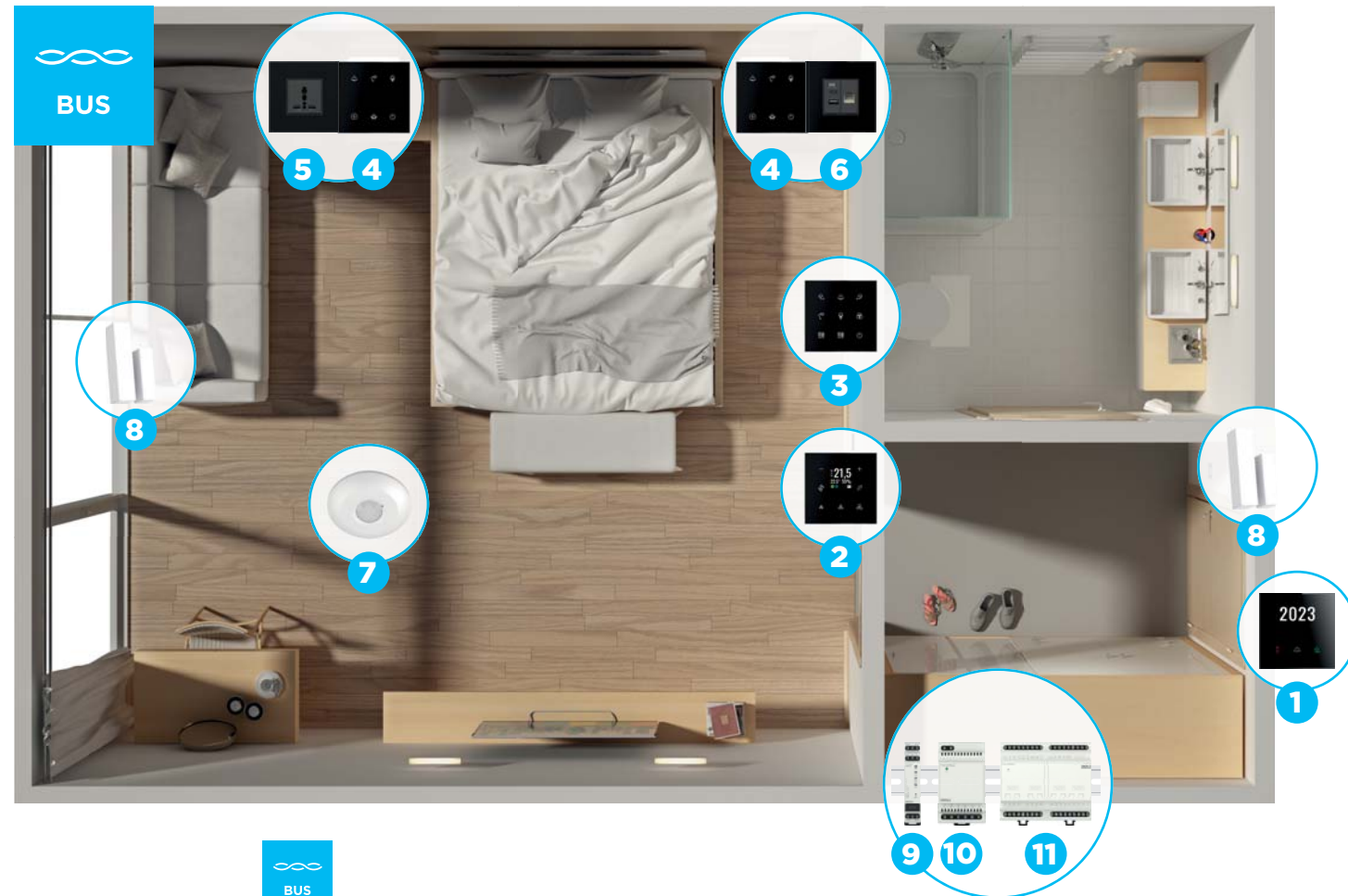

BUS	
Control	•
Lighting	•
Temperature	•
Access	•
Curtains	•
Courtesy	•
Audio	•
TV integration	•
Occupancy	•
Controllers	•
Plastic	•
Glass	•
Metall	•
Touch	•
Integration	•
PMS	•
HRS	•
iNELS App	•
Access/Lockers	•

- 1 Glass card reader
GCR3-30
- 2 Glass room thermo-regulator
GRT3-70
- 3 Glass switch panel - 9 buttons
GSB3-90S
- 4 Glass switch panel with symbols - 6 buttons
GSB3-60/S
- 5 AC power multistandard socket
GSS3-PMS
- 6 USB/LAN socket panel
GSS3-USB/LAN
- 7 Ultra slim PIR motion detector
PMS3-01
- 8 Door/window wired contact
- 9 Central unit
CU3-10M, MODBUS & MQTT gateway
- 10 Power supply
PS3-30/iNELS
- 11 Room controller with DALI dimmer
RC3-610M/DALI

DIN RAIL PANEL

Wireless	
Control	•
Lighting	•
Temperature	•
Access	•
Curtains	•
Courtesy	•
Audio	-
TV integration	•
Occupancy	•
Controllers	•
Plastic	•
Glass	•
Metall	x
Touch	•
Integration	•
PMS	•
HRS	•
iNELS App	•
Access/Lockers	•

- 1 Infront of door hotel room unit
RFBS-30/S, 24V/230V powered
- 2 Glass touch controller with symbols
RFSW-62/S, 24V/230V powered, MQTT gateway included
- 3 Glass touch thermostat for fancoils
RFTC-3, 230V powered
- 4 Motion detector for ceiling mounting
RFMD-200, battery powered
- 5 Window/door detector
RFWD-100, battery powered
- 6 Glass touch controller, 4 buttons
RFGB-40, battery powered
- 7 Switch unit, 2 channels
RFSAI-62B-SL, 230V powered
- 8 DALI controller, 4 DALI balast
RFDALI-04/B-SL, 230V powered

Look how HRESK works



Classic with a touch of nature

The WSB3 full-screen pushbutton controllers bring a wide range of colour and frame material combinations from the Logus90 range. Whether you choose a completely classic white plastic frame, a pastel-coloured Animato frame or a glass, wood, metal or stone frame, there is always a fingerboard in a matching colour to go with your chosen frame.

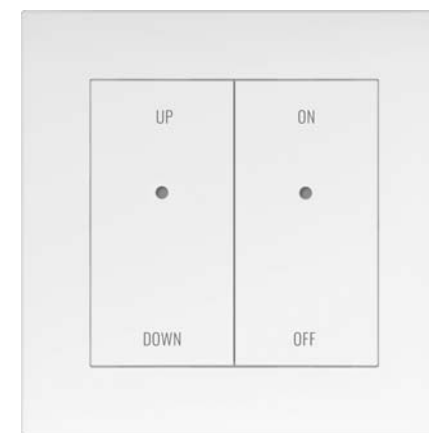
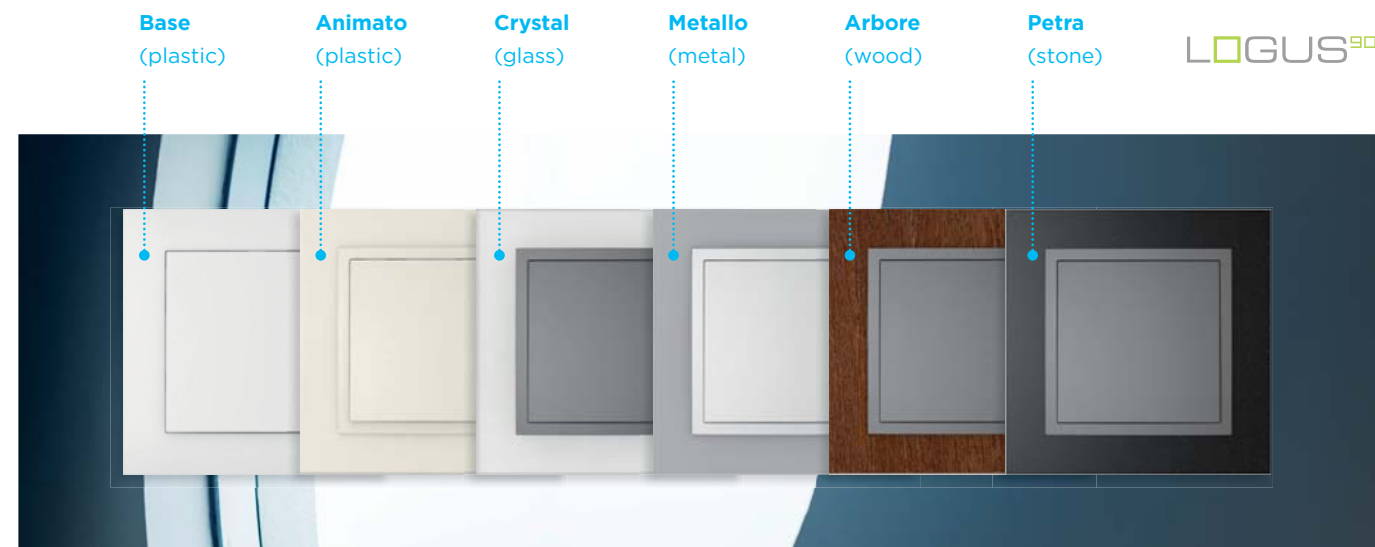

2 and 4 button versions are available, equipped with a two-colour signal LED whose function can be defined in software. The drivers include a temperature and humidity sensor as well as an input for an external wire contact or temperature sensor.

Design & Function in one controller

Glass panels stand out in any interior - even in a hotel or at home. Whether round or sharp, in black or white glass, there are always 4, 6 or 9 buttons available. The buttons are backlit, and the colours and brightness of the backlight can be set by software, as can the acoustic signal when pressed.

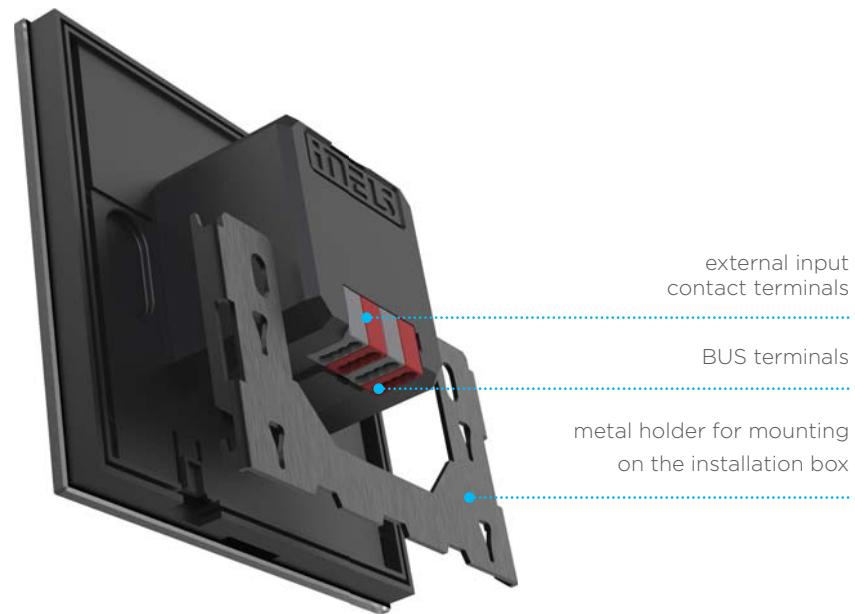
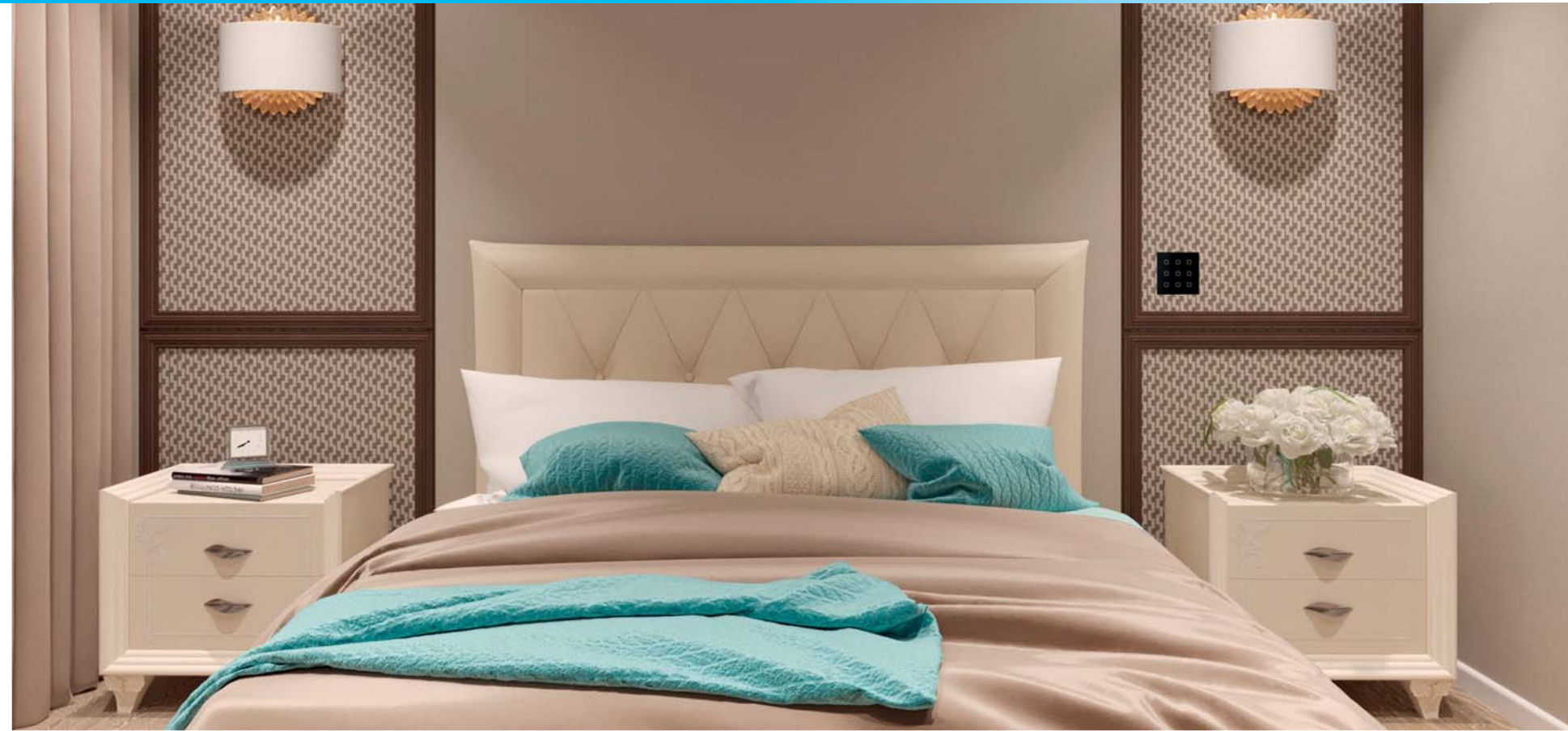

GSB3-XXX/SXX

- P - proximity sensor
- B - black glass
W - white glass
- S - symbols
- 40 - 4 buttons
60 - 6 buttons
90 - 9 buttons
- () - sharp
2 - round
- Glass Switch Button



Black round glass / 4 buttons



Black sharp glass / 6 buttons



White Sharp Glass / 9 buttons

Any icon and text description can be applied to the button position (see icons.inels.com configurator). The glass control panels contain temperature and humidity sensors as standard. SWP/SBP versions also include a proximity and ambient light sensor, which allows the backlight to be activated in the dark and then does not disturb the guest at night. In addition, each panel is equipped with an external input for connecting a wired contact or temperature sensor.

Make your design:
icons.inels.com

Luxury without compromise

The new range of metal control panels combines the luxury of metal surfaces with the elegance of a classic button press. Four finishes are available - for both panels and buttons: Brushed Silver, Satin Brass, Antique Copper or Graphite Black.

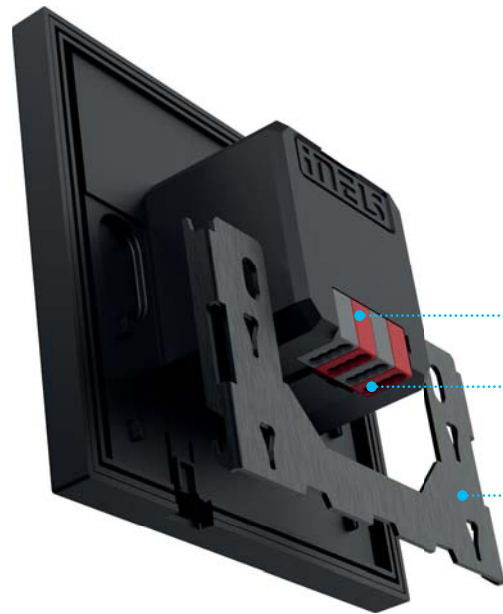
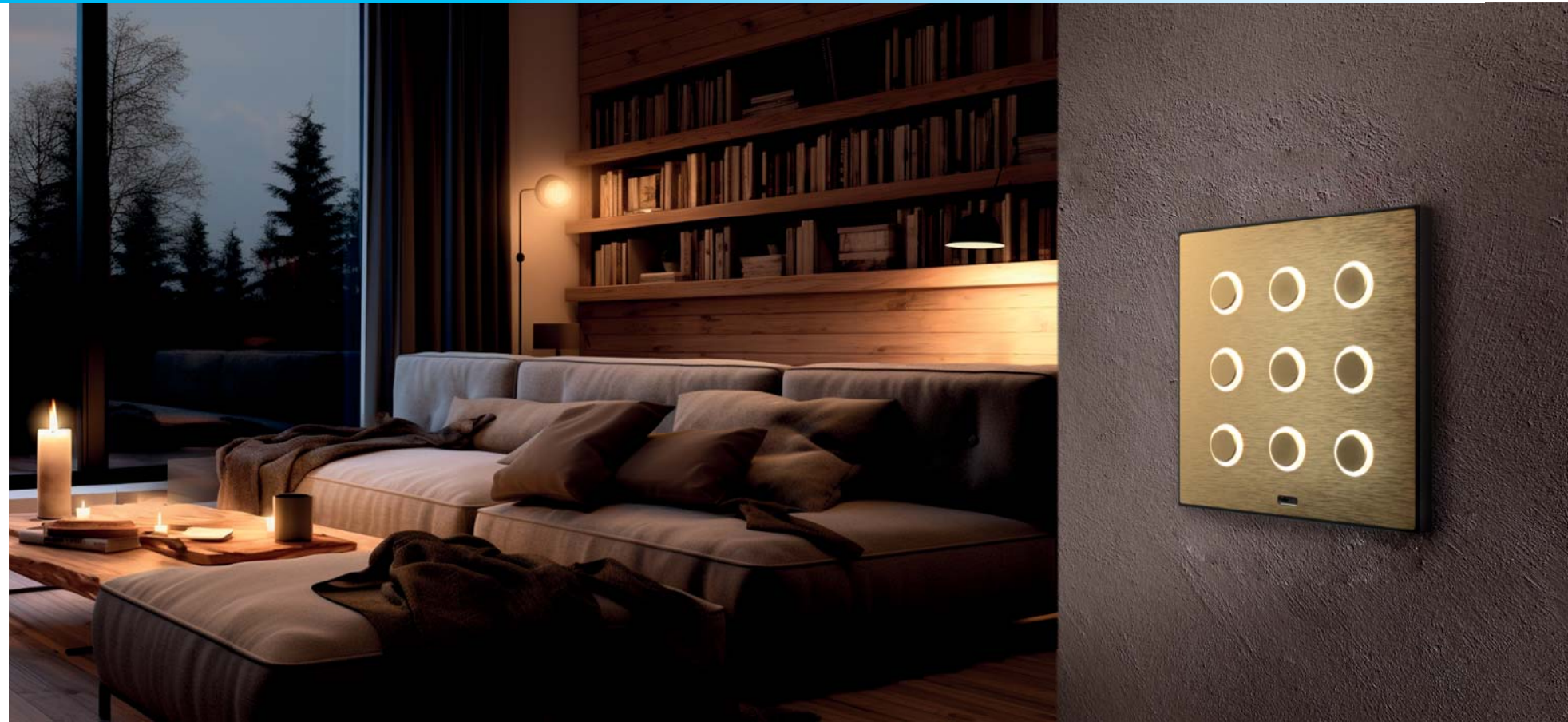

external input contact terminals

BUS terminals

metal holder for installation on the fixing box

MSB3-XX/SS

- **Button finishes:**
G - Satin brass
B - Graphite black
S - Brushed silver
C - Antique copper
- **Plate finishes:**
G - Satin brass
B - Graphite black
S - Brushed silver
C - Antique copper
- **40** - 4 buttons
60 - 6 buttons
90 - 9 buttons
- **Metal Switch Button**



Antique Copper / 9 buttons

White LED backlight

light sensors



Brushed Silver / 4 buttons



Satin Brass / 6 buttons



Graphite Black / 9 buttons

The white backlighting of the buttons, whose function and brightness can be defined by software, adds an even higher level of comfort to the chosen design. The panels can be freely customized with icons and text - see icons.inels.com configurator.

Make your design:
icons.inels.com

Integral part of the control panels

Socket panels are an essential part of every hotel room's controls. They replicate the designs of the glass GSB and metal MSB controllers. Various device modules can be inserted into the frames : 110/230V multistandard socket, USB A+C, HDMI, LAN, PIR and others. You can thus create combinations to suit your wishes, whether for your bed, TV or desk.

Glass plates finishes

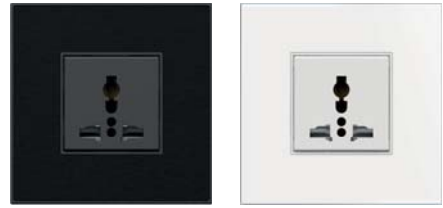

GSS3-PMS/B
B - Black glass

GSS3-PMS/W
W - White glass

Metal plates finishes

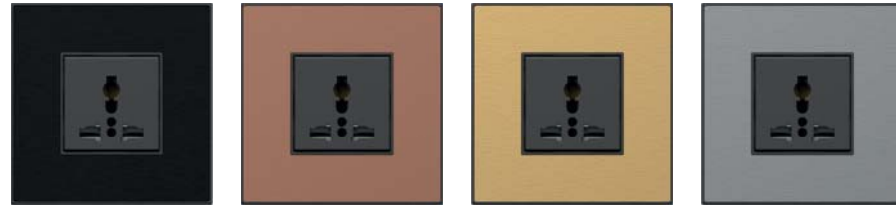

MSS3-PMS/B
B - Graphite black

MSS3-PMS/C
C - Antique copper

MSS3-PMS/G
G - Satin brass

MSS3-PMS/S
S - Brushed silver

For the design variants, the PMS multistandard socket in matt black is used. These devices are available in polar white and matt black. The hole in the GSS3/MSS3 can be filled with a 2Module accessory or 2x 1Module. A 1Module blind cover is available.

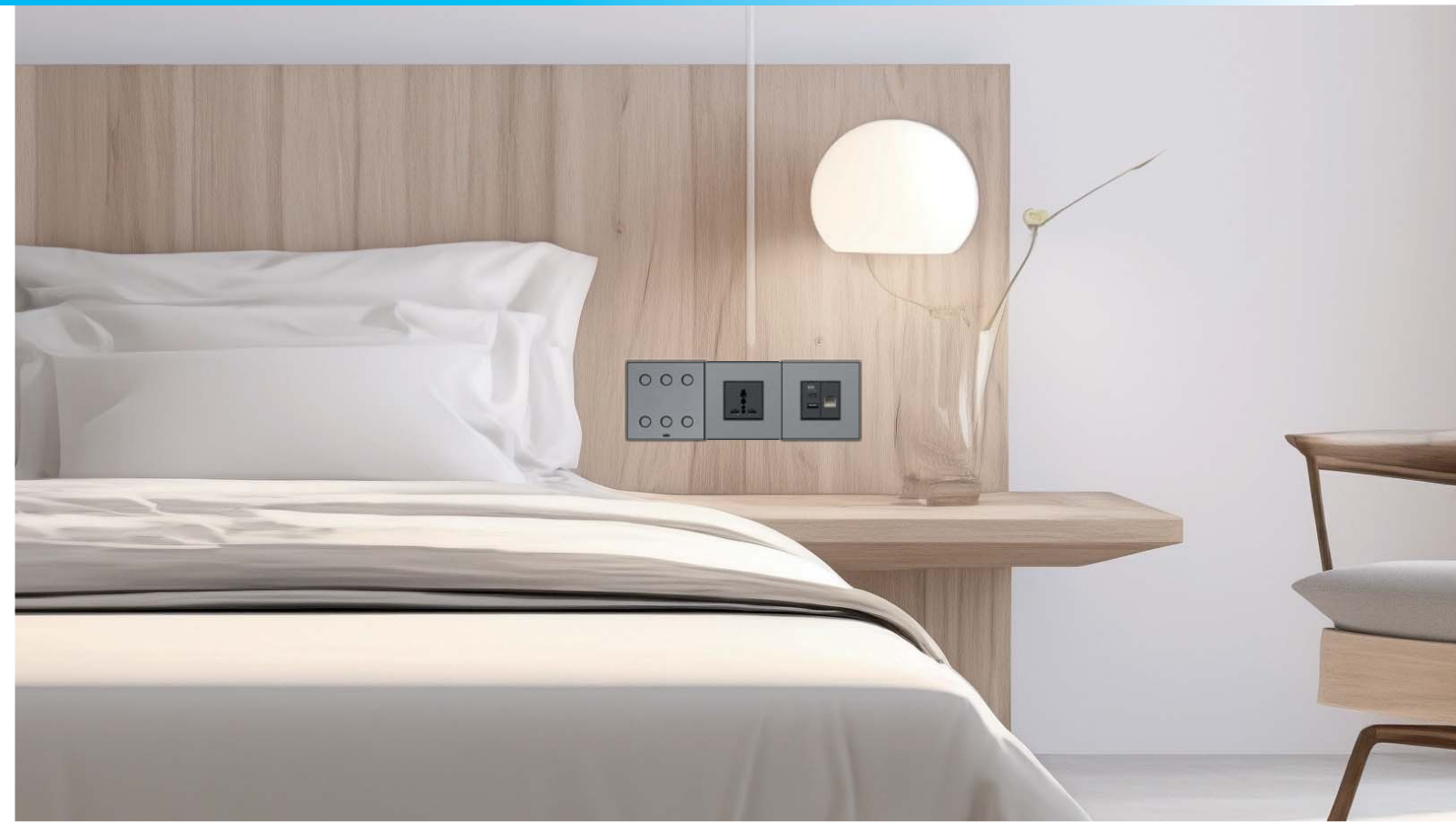

Blind cover 1-modul

PIR 1-modul

USB A+C 1-modul

HDMI 1-modul

LAN 1-modul

Multistandard socket 2-modules

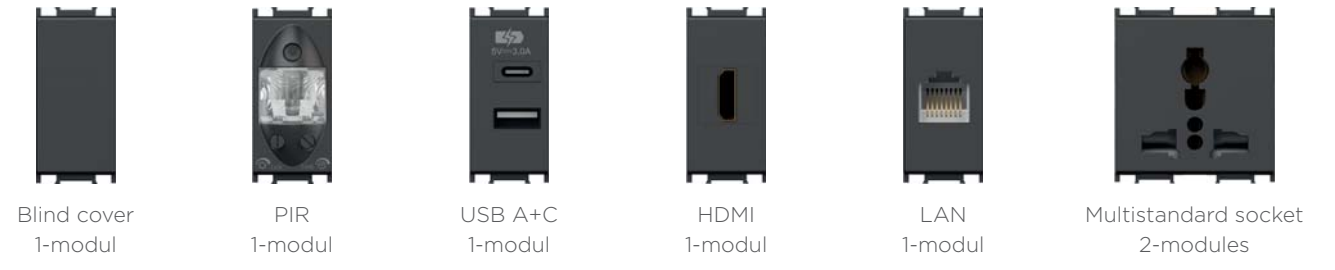

Blind cover 1-modul

PIR 1-modul

USB A+C 1-modul

HDMI 1-modul

LAN 1-modul

Multistandard socket 2-modules



Glass switch buttons with symbols

AC power multistandard socket PMS

USB-A+C sockets & LAN RJ45



USB-A+C sockets & LAN RJ45

AC power multistandard socket PMS

Metal switch buttons with indicators

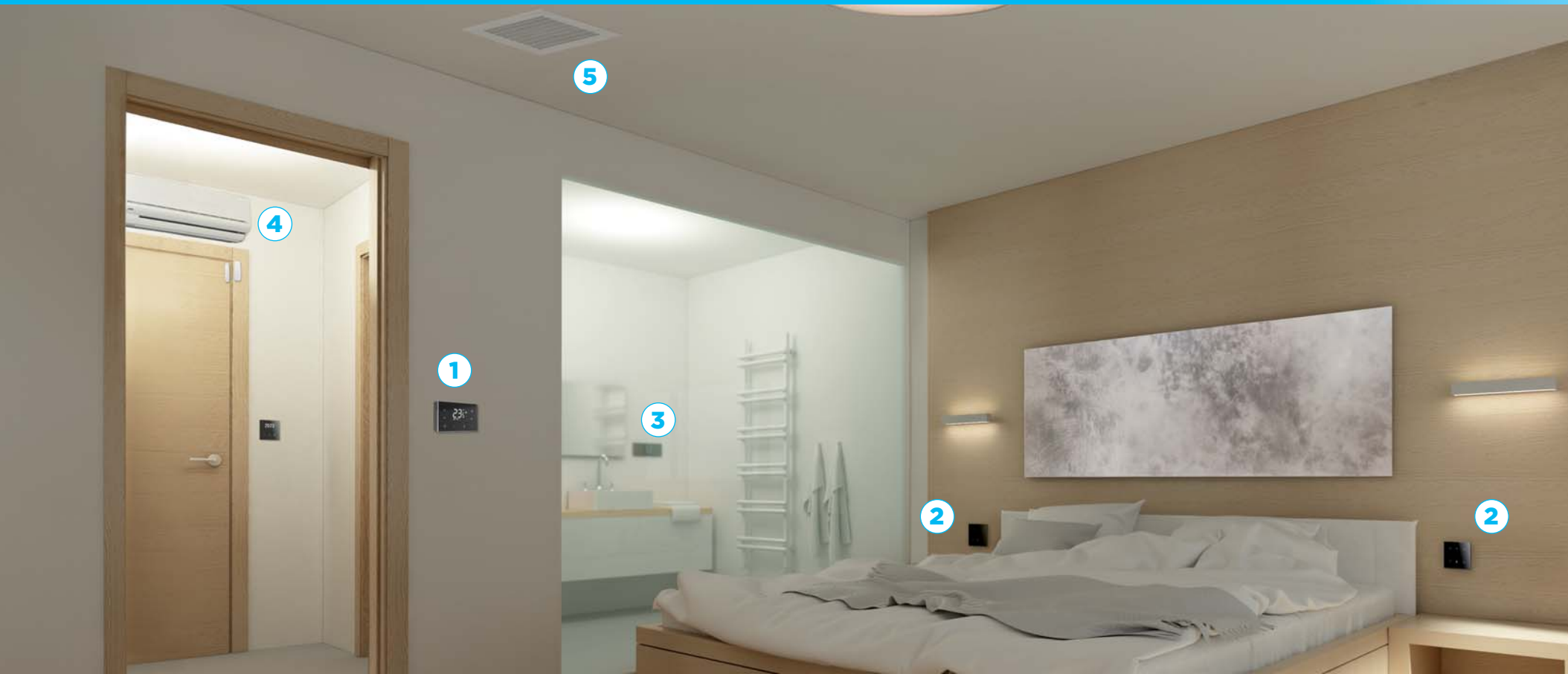

A/C control

ACI-ETH

It is used to connect the iNELS system with the most common types of air conditioners. It connects to the communication bus of the indoor split unit and to the system via Wifi using the MQTT protocol.

Comfort requires the right temperature

Temperature control is an essential part of every hotel room. iNELS thermostats are intuitive for guests and can control 2 and 4 pipe fan coils, central heating radiators or electric floor heating. They work with the most commonly used air conditioning and VRV systems. They have been developed with a focus on energy saving where they set the correct thermal mode together with other detectors (window, door, motion) and save at the same time. Central temperature control from a monitoring centre or reception is also an option.

WALL MOUNTED



Glass Thermostat for Fancoils

GRT3-100

Glass thermostat with output relays for direct switching of fan coils. Connection and power supply via iNELS BUS, configuration via iDM. Control of temperature, heating/cooling mode, fan speed and MUR/DND. Surface mounting, glass colour white or black. Built-in temperature, humidity and proximity sensor that activates backlighting of display and buttons at night.

FLUSH MOUNTED

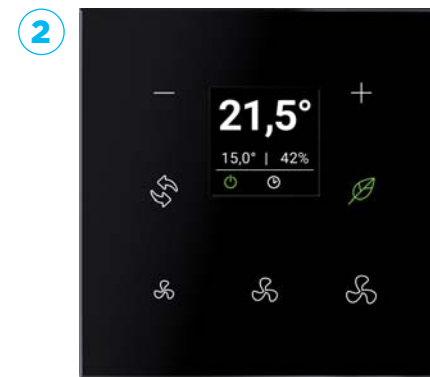

Glass Room Thermoregulator

GRT3-70/B

Glass thermostat for correction of heating circuits defined in iDM. Connection and power supply via iNELS BUS or MODBUS. Temperature and mode control. Installation in EU/BS installation box, glass design white/black, sharp/round corners. Built-in temperature, humidity sensor. Terminals for connection of external temperature sensor.

LOGUS⁹⁰ DESIGN

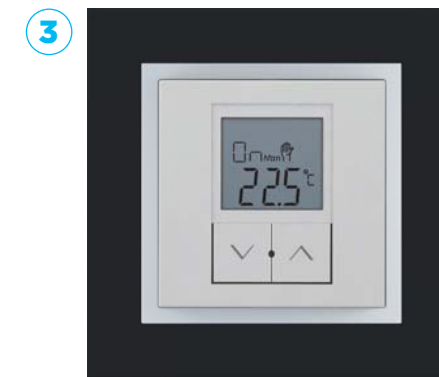

Simple Room Thermoregulator

IDRT3-1

Simple plastic thermostat for correction of heating circuits defined in iDM. Colour combinations of covers and frames within the wide Logus90 range. Built-in temperature sensor and input for external temperature sensor TC/TZ.



Fancoil Unit Controller

FA3-612M

Actuator is used to control fancoil's units via an analog/digital inputs. Analog inputs are for temperature measurement, voltage or current. Connection is to installation BUS.

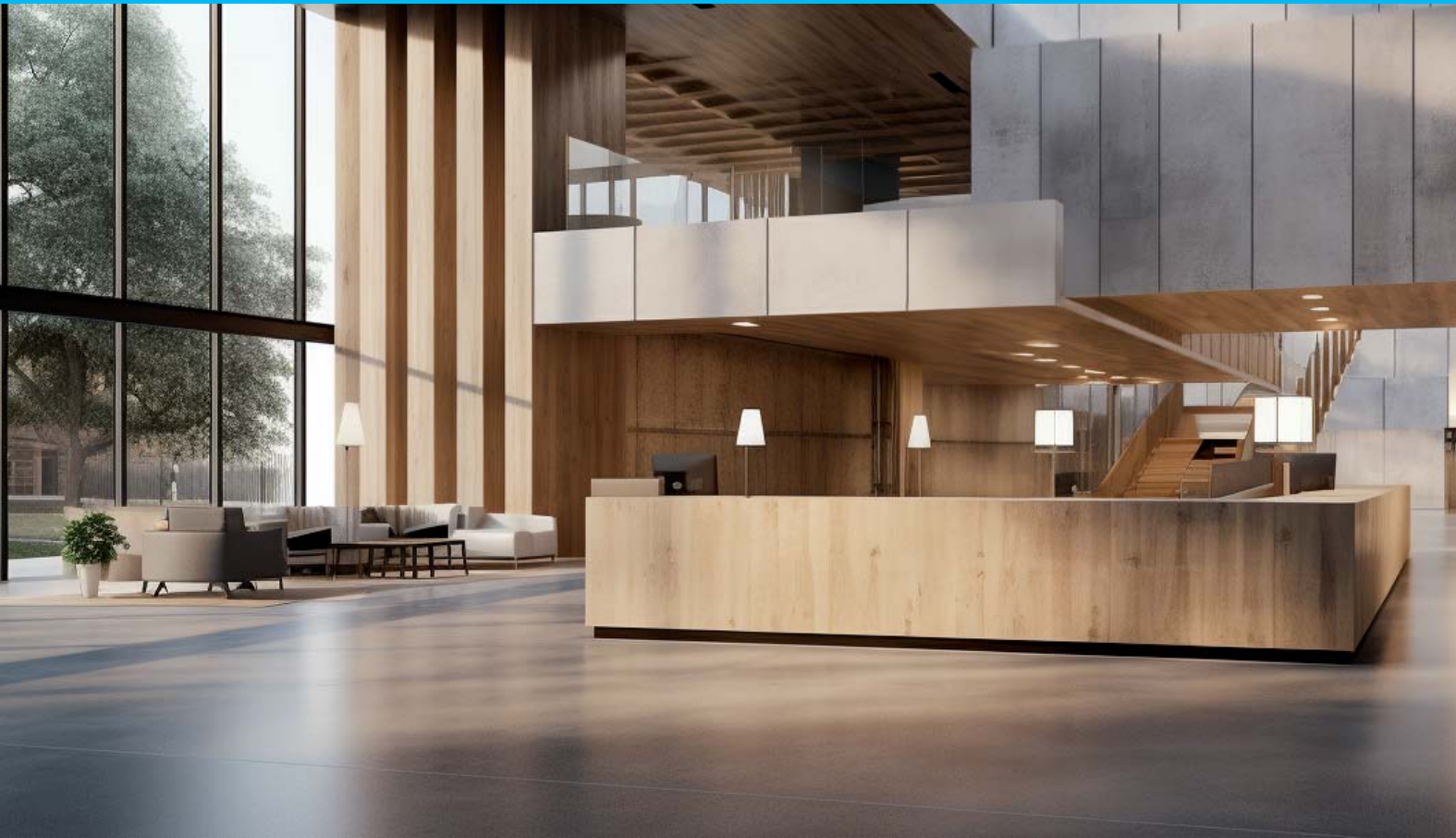

Room control card

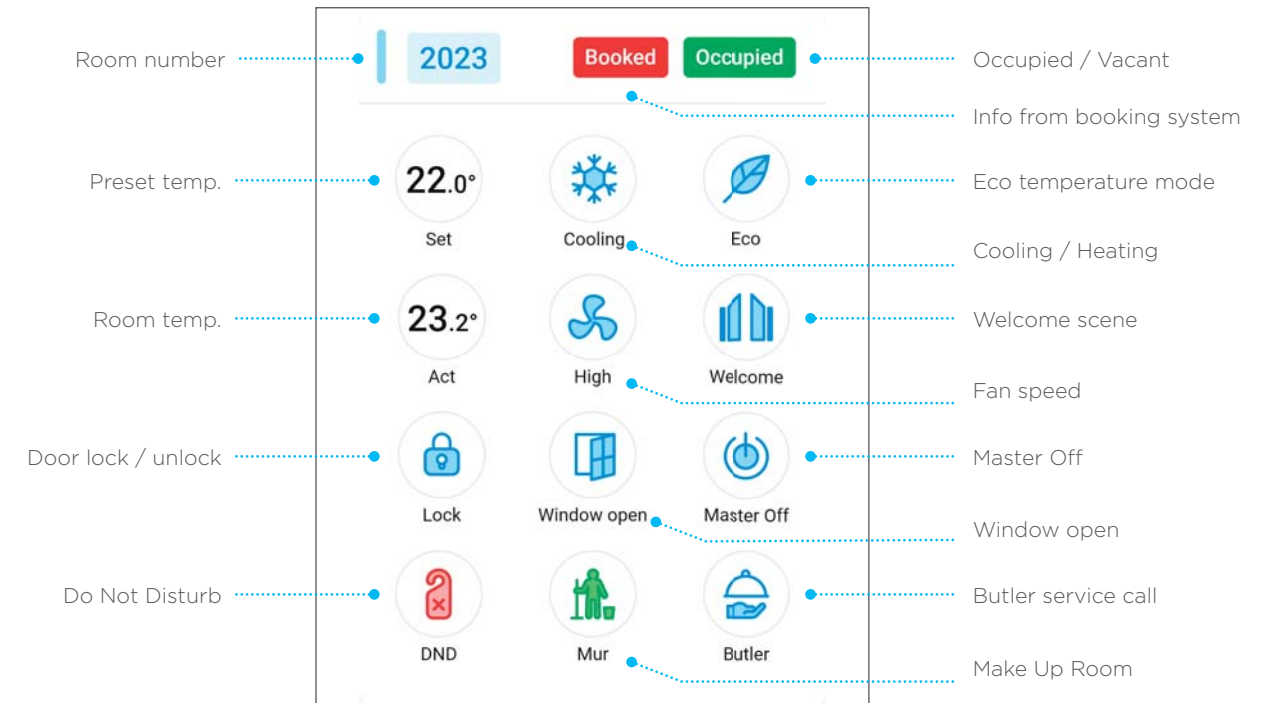

iNELS Hospitality offers a simple HRS (Hotel Reception Software) console that allows you to monitor the status of the room, including occupancy, MUR/DND and also allows you to control some of the functions: temperature, lighting, welcome scene. The software can be installed on a separate hotel server or it can be used in a Cloud version online.

Also included is a smart phone app for housekeeping that provides information on occupancy and cleaning requests.

Floor overview

1st Floor

Room cards: 201, 202, 203, 204, 205, 206

Control center: Set Temperature 22.0°, State of Heating Heating, Mode Auto, Eco, 1, 2, 3

Notifications:

Room 101	MUR	06-06-2023 10:20
Room 103	MUR	06-06-2023 10:24
Room 105	Butler	06-06-2023 11:15

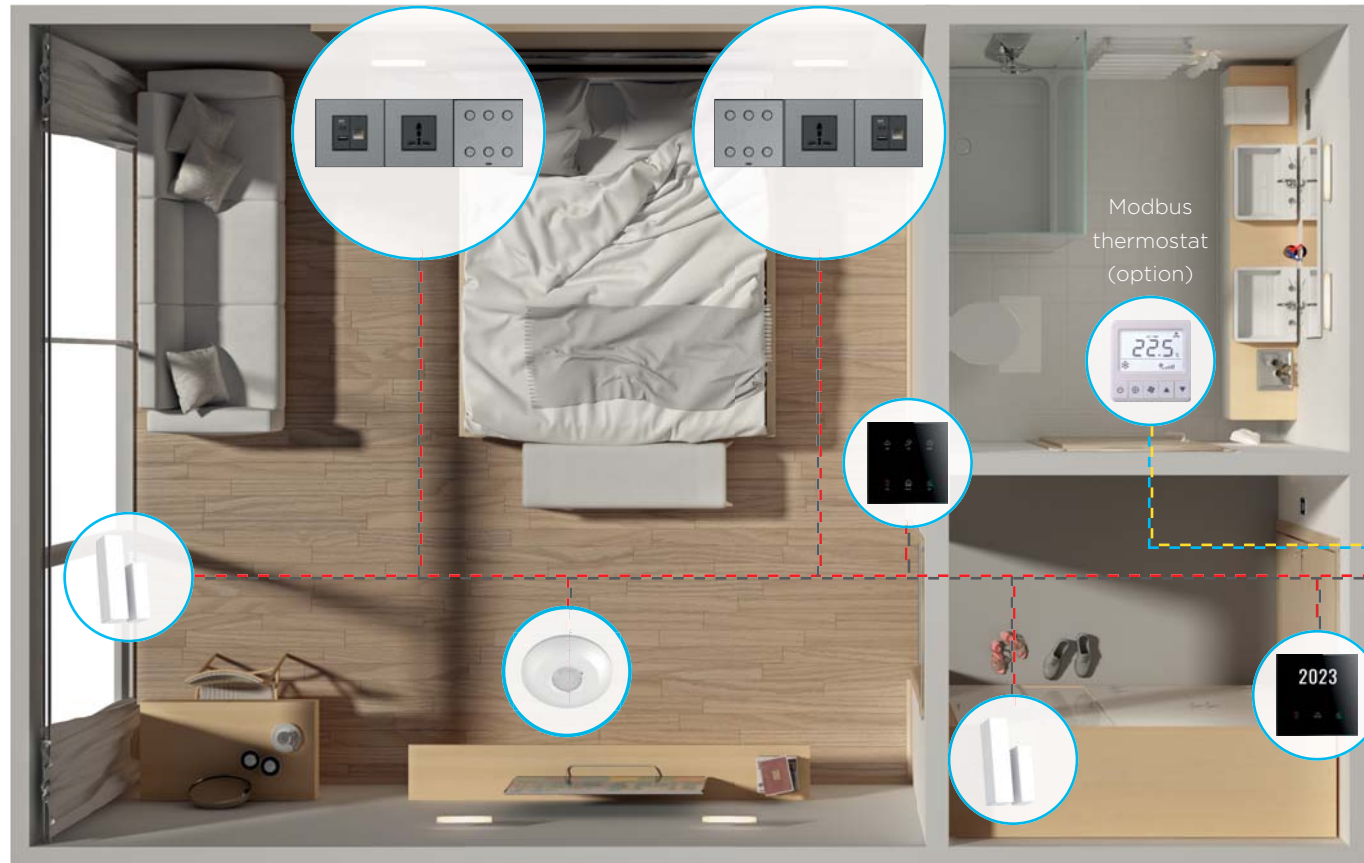

The iNELS GRMS includes a unique solution of units in the panel on DIN rail: in a minimal size covering all needs and requirements.

The heart of the system is the miniCU central unit, which includes an iNELS BUS for connecting up to 32 BUS units, a MODBUS bus for connecting thermostats and fancoils (if used) and a LAN port for IP connection to the higher-level system. It is also an MQTT gateway and firewall for security and protection of data transmissions.

Switching and dimming is then provided by a combined I/O unit which offers: 8x relay contacts for switching lighting or Relay 1 - Relay 5 can be used for switching fan coils, 6x digital inputs of which 2 can be used for connecting temperature sensors, 2x analogue outputs and last but not least a DALI master for dimming/dimming up to 16 DALI devices (DALI ballasts).

Together with the power supply, this powerful and compact backend occupies a width of only 10 modules on a DIN rail in a rack, while providing enough capacity to control a presidential suite.

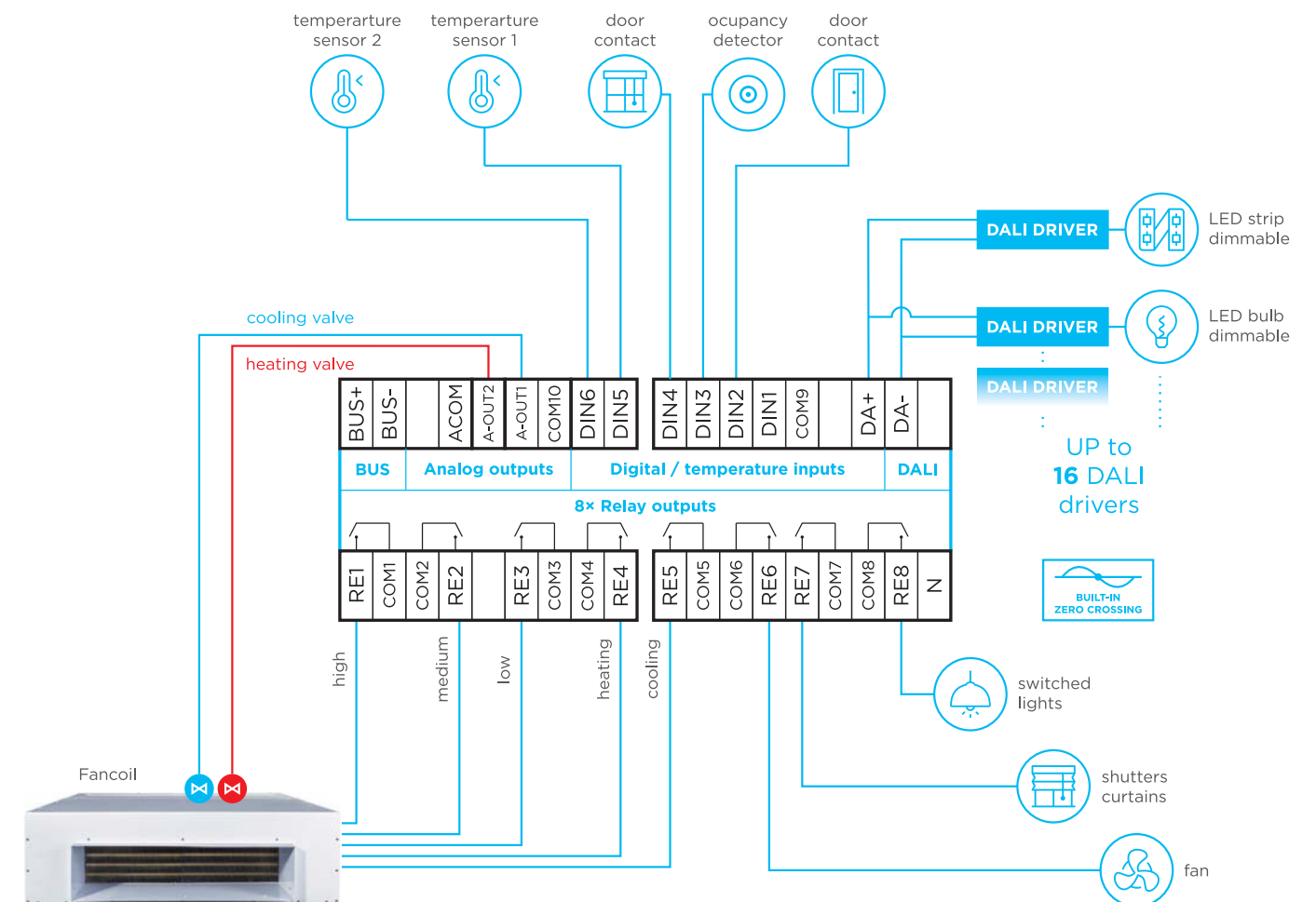
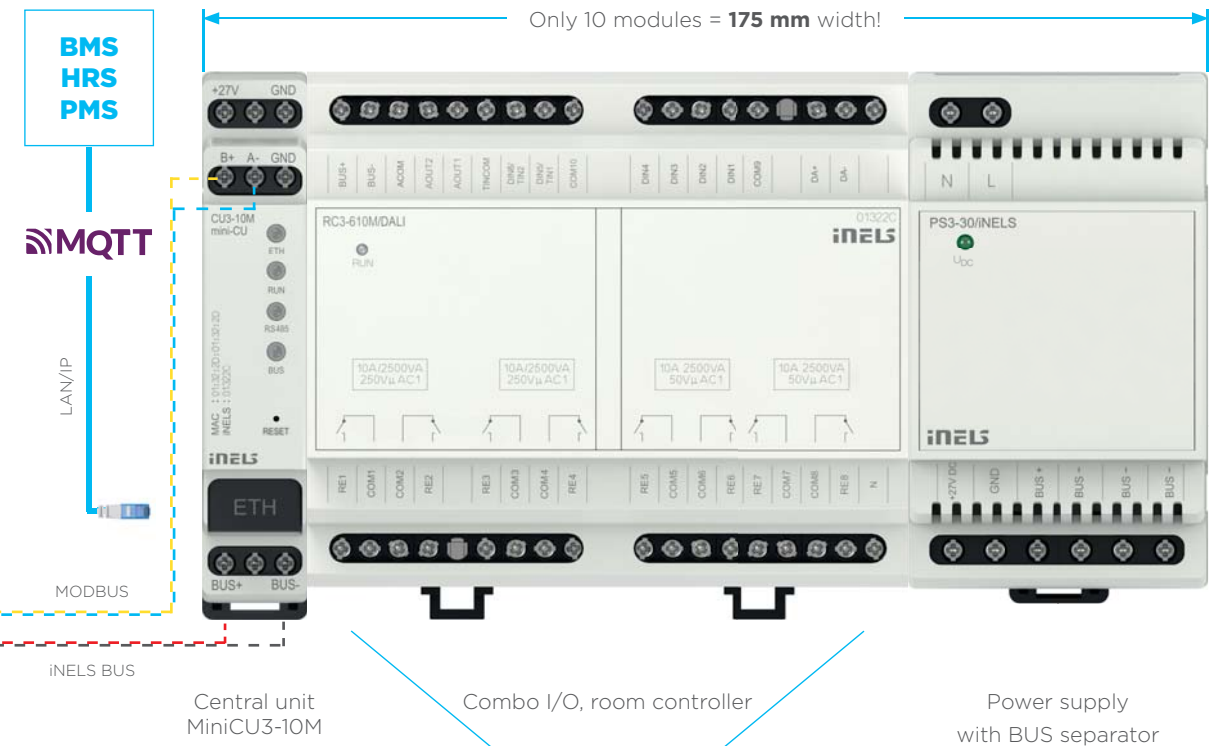

Part of iNELS Hospitality is LARA - internet radio and music player. Connection and power supply is provided by LAN with PoE, control is possible by touch buttons or via phone application. The device also includes a 2x10W amplifier, the power of which is sufficient for sounding a bathroom or even a room. The design of the enclosures and frames can be matched with Logus90, which also offers speakers for multiple frames.



Music & Power Kit

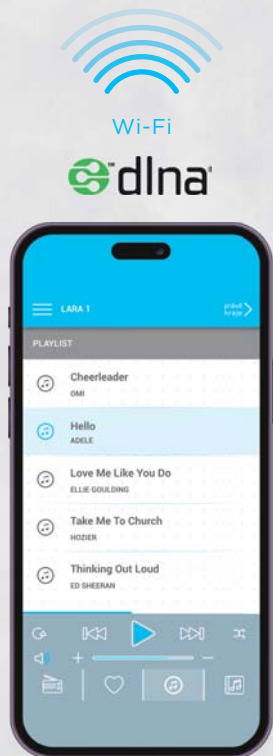

App LARA Dio



Additional Control Button



Thanks to the iNELS app for Samsung's Smart Hospitality TV, you can control the temperature, lighting, request cleaning or select do not disturb mode from the hotel room TV screen.

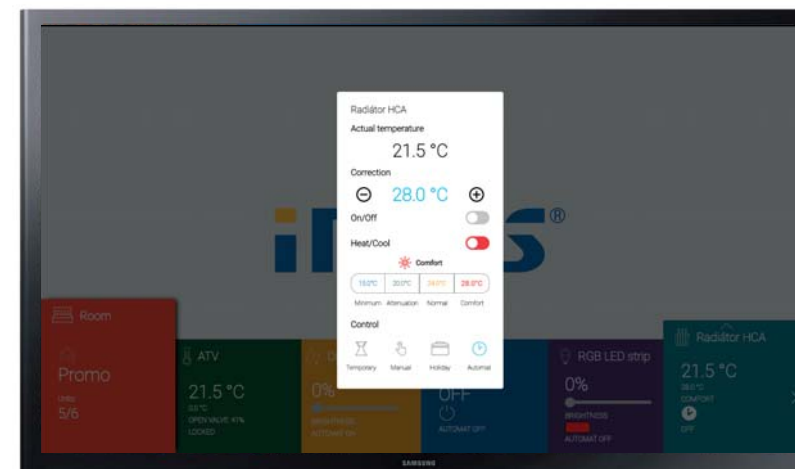

Room Control

Hotel managers can easily manage and arrange the channel mix for both analogue and digital channels without the need to adjust and edit channel lists by different TV systems. Channels can be reordered and renamed to the hotel's preference with channel mapping.

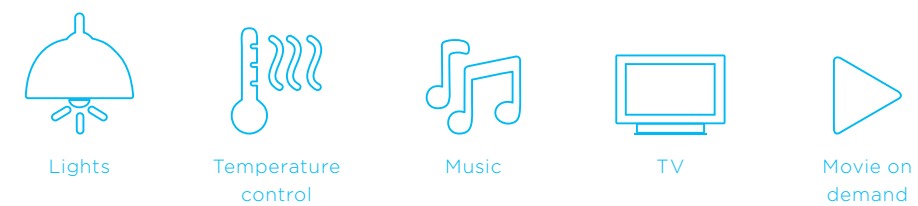



Integration with door lock manufacturers is a matter of course. Thanks to the interconnection, we receive information about the first entry into the room (triggering of the Welcome scene) and information about the occupancy of the room together with the motion detector in the iNELS system.

The room occupancy has a major influence on the energy management in the room, where it is possible to switch off all lights (or other electrical appliances) and set the attenuation temperature.



iNELS Digital Key

This smartphone app with a digital key (IDK) is another smart way how to unlock you room if you don't have a card with you.

Glass Card Reader GCR3-30/SB

The RFID card reader is a great design for the entrance to the rooms which also features a bell signal the "Do Not Disturb" and "Make Up Room" signs and backlighted room number. Thanks to the integrated relay it can control the door lock directly.

Card type: Mifare 1k, 4k, Ultralight, DesFire, ISO/IEC 14443-4 (CD97BX, CD light, P5CN072 (SMX) Innovision jewel (IRT5001), FeliCa (RCS_860, RCS_854)

Frequencies: 13,56 MHz

Glass Card Reader GCR3-30/SW

* The picture of device is illustrative, the icons (symbols) are configurable by the customer.



Common areas - such as corridors, reception, lobbies, restaurants, bars, wellness and related facilities are an integral part of every hotel. Here too, lighting and temperature must be controlled, usually according to a different mode. Part of iNELS GRMS are units that can control multiple circuits or more power.

For example, the DA3-66M dimmer can dim up to 6 independent dimmable circuits, the SA3-22M switching actuator can switch up to 22 relay outputs or the CU3-09M can control up to 64 DALI addressable dimmable luminaires. This will undoubtedly have a positive effect on the purchase price of the entire system.

Just like the controls, the power elements follow the latest technological trends: switching output relays with ZERO-CROSS make it possible to switch even current-consuming LED lighting - unless you prefer to directly select dimmers with DALI interface, which are included in both versions of the iNELS Hospitality system.

6x
DIMM



Phase dimm
up to 6 circuits

DA3-66M Dimmer

The RC3-610M/DALI is an I/O actuator equipped with 6 binary inputs, of which 2 can be configured as temperature inputs and 8 independent relays with switching potential-free and potential contacts.

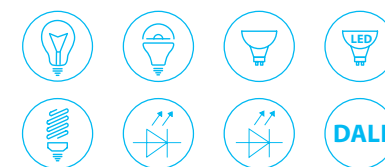

14x
SWITCH



Switching actuator
for 14 units

SA3-014M Switching actuator

The actuator is designed for switching various appliances and loads with Zero Crossing technology.



64
DALI ADDRESS



Central unit
for DALI

CU3-09M-DALI

CU3-09M is a control unit in iNELS BUS installations, working independently or as part of a larger project. It includes one BUS line, it can connect up to 32 iNELS BUS elements and includes a DALI bus for controlling up to 64 DALI ballast addresses. The unit employs MQTT for third-party communication and supports direct cloud communication for mobile app control.

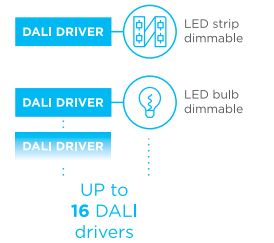

Central units



CU3-08M
Central unit
with 2x BUS,
max. 64 units



CU3-09M/DALI
Central unit
with 1 BUS, 1x DALI,
with 64 DALI addresses



CU3-10M
Central unit
with 1x BUS,
1x MODBUS

Detectors | sensors



MCD3-01
Ultra slim microwave
motion detector - ceiling
mount



PMS3-01
Ultra slim PIR motion
detector - ceiling mount

Input units



IM3-40B
Binary input unit,
4 inputs



IM3-80B
Binary input unit,
8 inputs



IM3-140M
Binary input unit,
14 inputs



TI3-40B
Temperature input,
4 inputs



TI3-60M
Temperature input,
6 inputs

Switching actuators



SA3-01B, SA3-02B
Switching actuator,
1 channel and 2
channels



SA3-04M
Switching
actuator,
4 channels



SA3-06M
Switching
actuator,
6 channels



SA3-014M
Switching actuator,
14 channels



SA3-014M/E
Switching actuator,
14 channels (without
manual control
buttons and RE
status LED)



SA3-022M
Switching actuator,
22 channels



EA3-022M
Switching actuator
without controls and
indicators,
22 channels

Power supplies



PS3-30/iNELS
Power supply
with integrated BUS
separator



**BPS3-01M,
BPS3-02M**
Bus separator
from power supply



PSM3-30/iNELS
Power supply
for iNELS BUS



PSM3-60/iNELS
Power supply
for iNELS BUS



PSM3-100/iNELS
Power supply
for iNELS BUS

Lighting control



DA3-22M
Universal dimming
actuator,
2 channels



DA3-66M
Dimming actuator,
6 channels



DA3-03M/RGBW
Dimming actuator
for RGBW strips

Shutter actuators



JA3-014M
Shutter actuator,
14 channels



JA3-014M/E
Shutter actuator,
14 channels (without
manual control
buttons and RE
status LED)

Combined units



RC3-610M/DALI
Room controller
with DALI dimmer



FA3-612M
Fancoil controller



IOU3-108M
Universal unit with
10 inputs and 8 outputs

Wall controllers, LOGUS⁹⁰ design

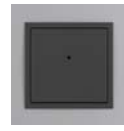

WSB3-20, WSB3-20H
Wall switch button,
2 buttons



WSB3-40, WSB3-40H
Wall switch button,
4 buttons

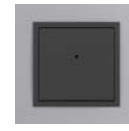

WMR3-21
Wall card reader



GCR3-30
sharp
Glass card reader



GCR3-230
round
Glass card reader

Card readers

Thermo-regulators



IDRT3-1
Digital room
thermo-regulator



GRT3-70
sharp
Glass room
thermo-regulator



GRT3-270
round
Glass room
thermo-regulator



GRT3-100
Glass room on-wall
thermo-regulator with
relays for fancoils control

Glass controllers

Touch units



GSB3-40
sharp
4 buttons



GSB3-60
sharp
6 buttons

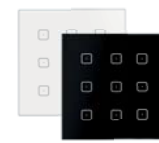

GSB3-90
sharp
9 buttons



GSB3-240
round
4 buttons



GSB3-260
round
6 buttons



GSB3-290
round
9 buttons



EST4
4" touch
control panel



EST8
8" touch
control panel



EST10
10" touch
control panel



GSB3-40/S
sharp
4 buttons,
with symbols



GSB3-60/S
sharp
6 buttons,
with symbols



GSB3-90/S
sharp
9 buttons,
with symbols



GSB3-240/S
round
4 buttons,
with symbols



GSB3-260/S
round
6 buttons,
with symbols



GSB3-290/S
round
9 buttons,
with symbols

Integration

Multimedia



iNELS Bridge
Third-party integration
gateway



Connection Server II.
Third-party integration
server



LARA Radio
Player Internet radio

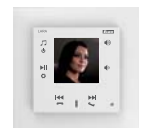

LARA Intercom
Multifunction communication
equipment

Metal controllers

iNELS app

Accessories

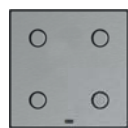

MSB3-40/SS
Brushed silver
4 buttons

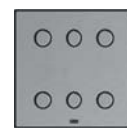

MSB3-60/SS
Brushed silver
6 buttons

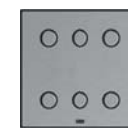

MSB3-90/SS
Brushed silver
9 buttons

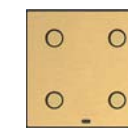

MSB3-40/GG
Satin brass
4 buttons

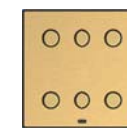

MSB3-60/GG
Satin brass
6 buttons

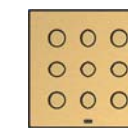

MSB3-90/GG
Satin brass
9 buttons

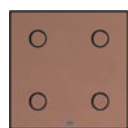

MSB3-40/CC
Antique copper
4 buttons

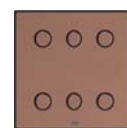

MSB3-60/CC
Antique copper
6 buttons

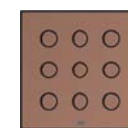

MSB3-90/CC
Antique copper
9 buttons



MSB3-40/BB
Graphite black
4 buttons

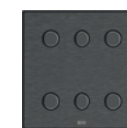

MSB3-60/BB
Graphite black
6 buttons



MSB3-90/BB
Graphite black
9 buttons



New application for controlling all compatible
elements from the iNELS portfolio.



TELVA-2 230V, TELVA-2 24V
Thermodrive



AN-I, AN-E
Internal antenna
External antenna



TC, TZ, Pt100
Thermo sensors

iNELS App for service

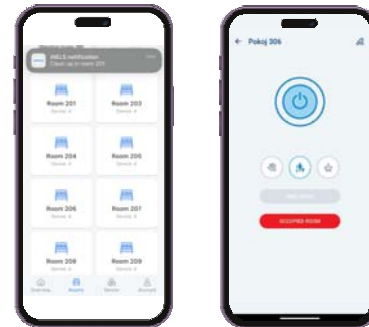

OR



Local Hotel Server on site

HOTEL

MQTT

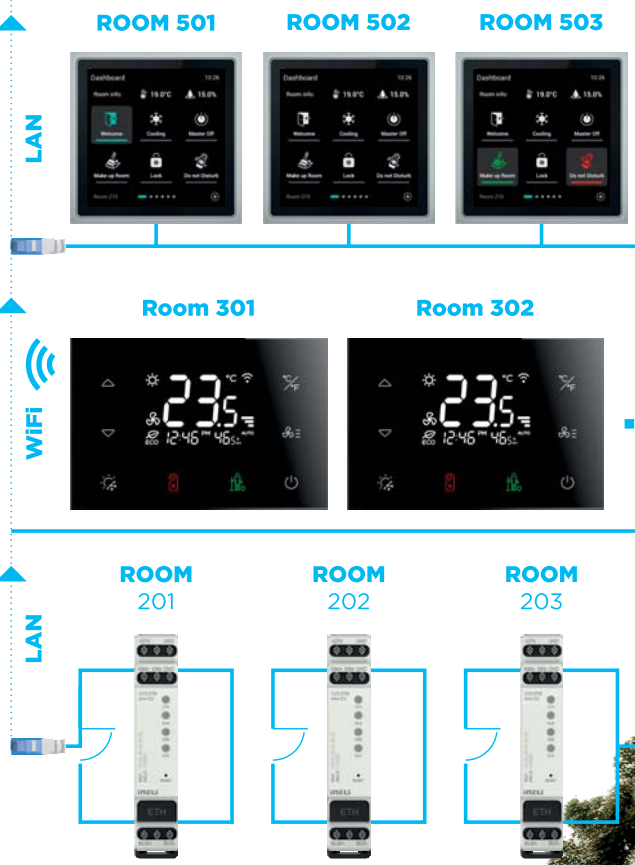

BACKEND

FRONTEND

HRS

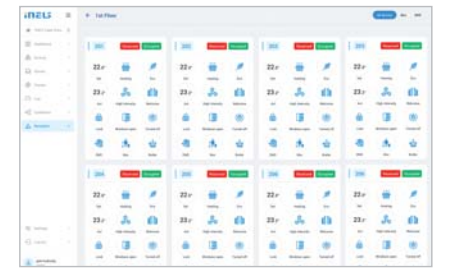
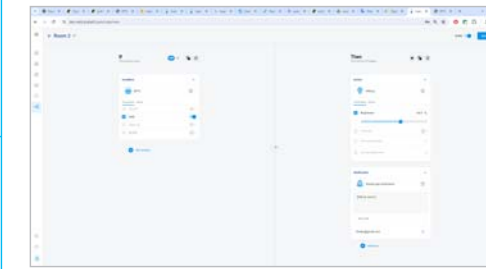

NodeRED

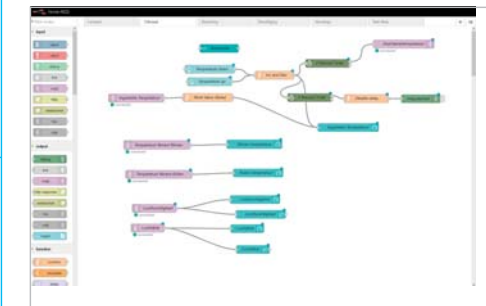

SkyThings

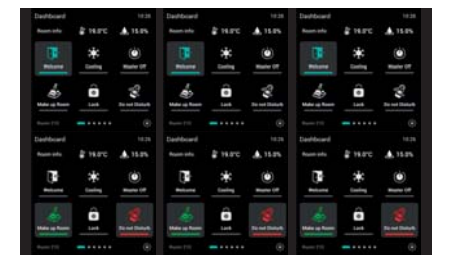
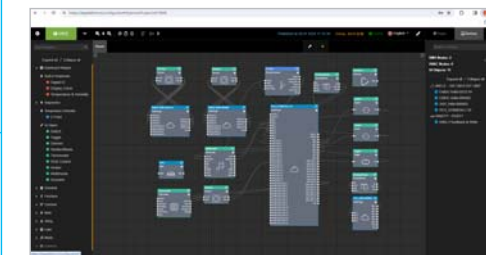

PMS

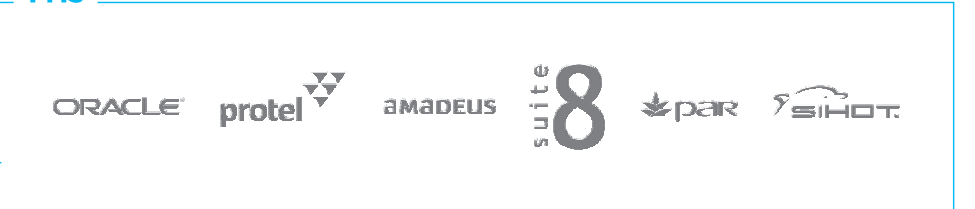

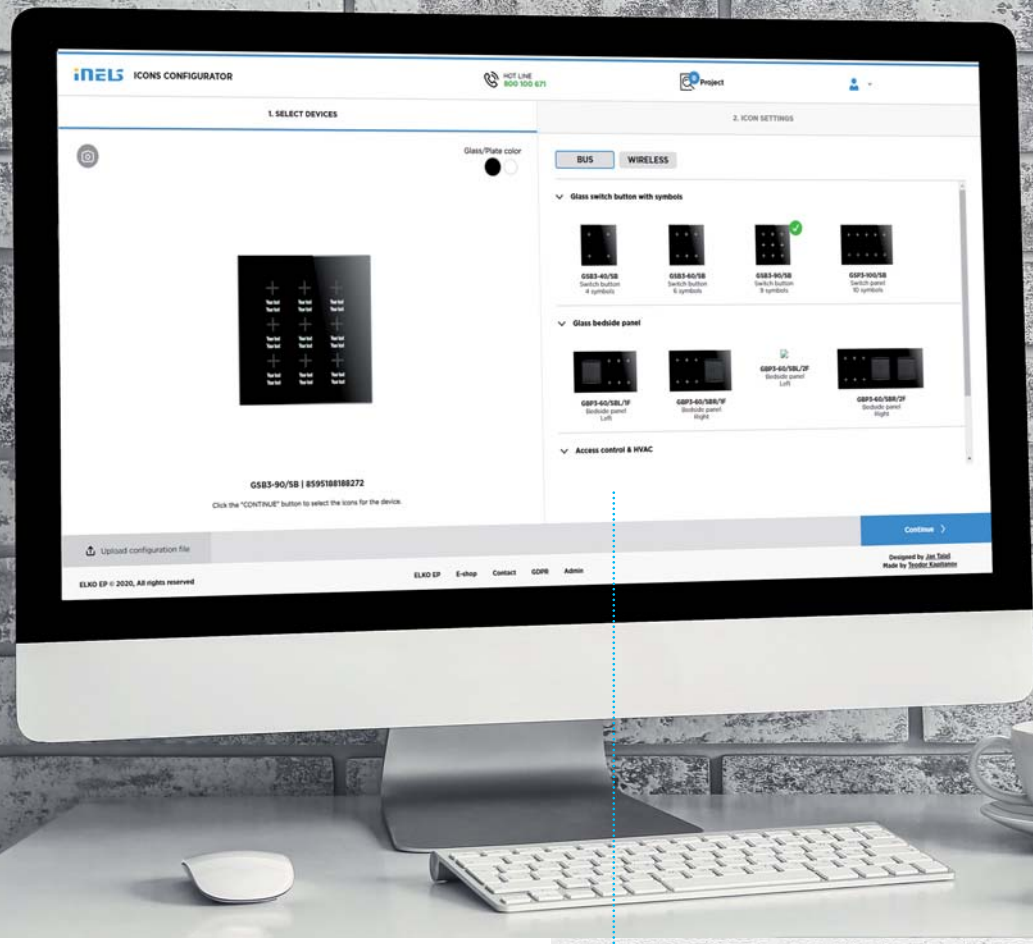

Online customization:
icons.inels.com

ELKO EP as a manufacturer has technologies that allow us to offer you a wide range of customization: colors of controls, shapes of glass, icons and button descriptions, including hotel room numbers and even hotel logos. Special and unusual combinations can be made on request.

We can supply the entire order with elements pre-programmed from the factory so that you only install them according to their codes in the correct room numbers. This will significantly reduce programming and commissioning costs.

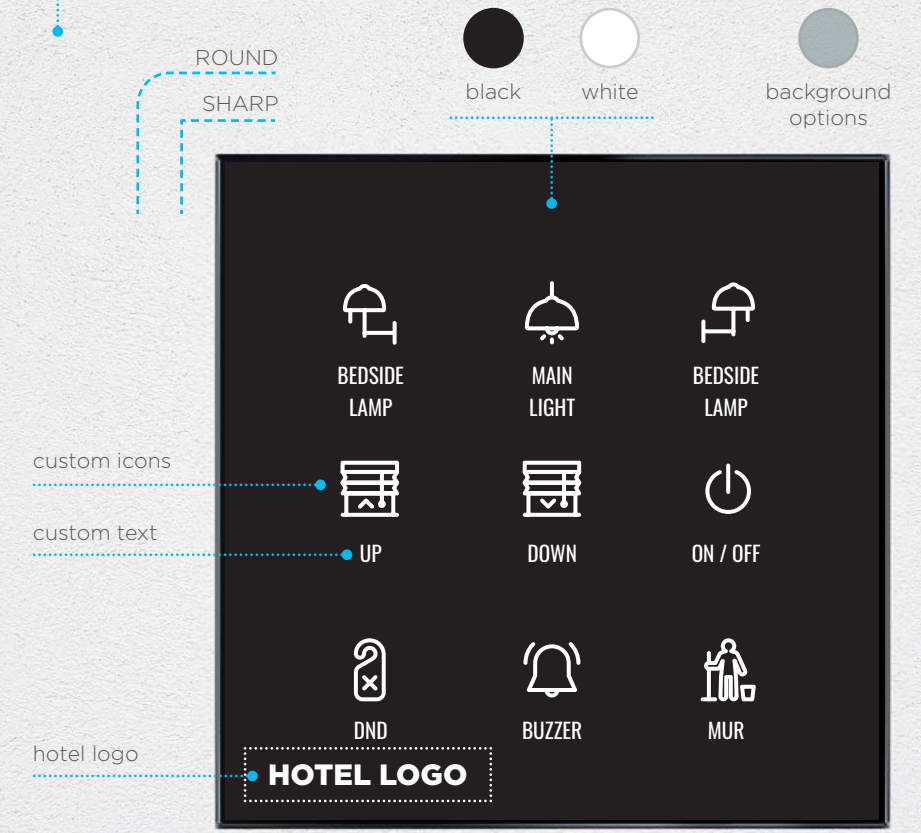

Icon library

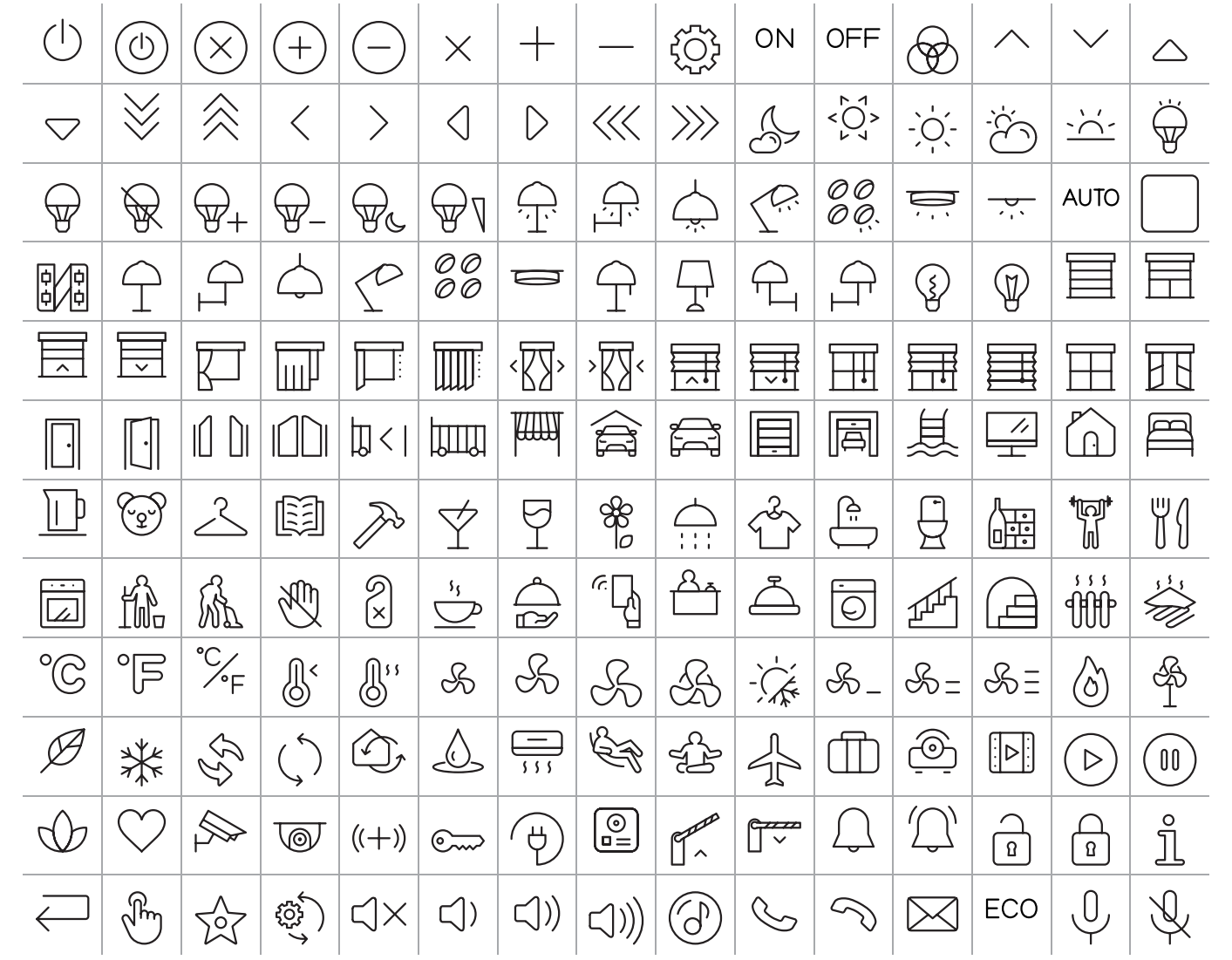

Glass colour selection



Black crystal (standard) **White crystal** (standard) **Blue crystal** **Red crystal** **Yellow crystal**

Other colours on request

Controllers – natural & plastic

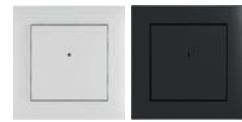

RFWB-20/G – white
RFWB-20/GB – black
On-wall button controller
– 2 buttons

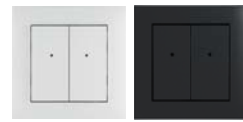

RFWB-40/G – white
RFWB-40/GB – black
On-wall button controller
– 4 buttons

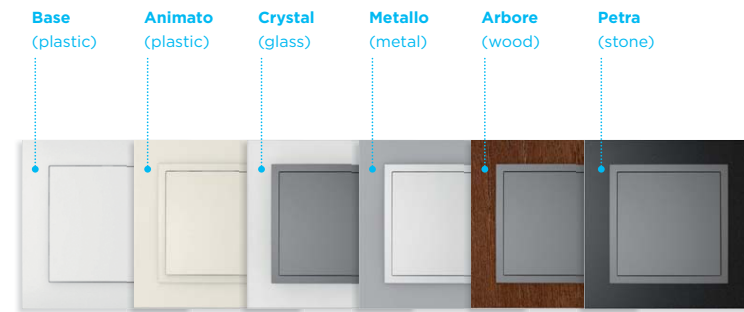

Controllers – glass



RFGB-20/W – white
RFGB-20/B – black
Glass touch controller
SHARP – 2 buttons

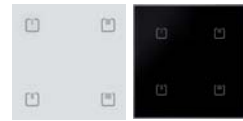

RFGB-40/W – white
RFGB-40/B – black
Glass touch controller
SHARP – 4 buttons



RFGB-220/W – white
RFGB-220/B – black
Glass touch controller,
ROUND – 2 buttons



RFGB-240/W – white
RFGB-240/B – black
Glass touch controller,
ROUND – 4 buttons

Controllers – glass with actuators

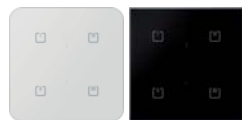

RFSW-62/B – black glass, SHARP
RFSW-262/W – white glass, ROUND
Glass touch controller
with output relays

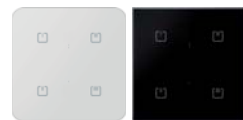

RFDW-71/B – black glass, SHARP
RFDW-271/W – white glass, ROUND
Glass touch controller
with dimmer

Courtesy units – glass with symbols

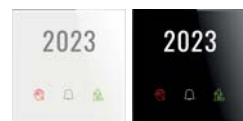

RFGS-30/SB – black glass
RFGS-30/SW – white glass
Infront of door hotel
room unit



RFSW-62/SB – black glass
RFSW-62/SW – white glass
Wireless touch glass remote
control with symbols and two
output relays

Switch units – flush mounted



RFS-61B
Switch unit, 1 channel
– 1x 16 A, multifunction



RFSAI-61BPF-SL
Multifunction switch unit
with inputs for external
buttons – 1x 8 A, with galva-
nically separated contacts



RFSAI-61B-SL
Multifunction switch unit
with inputs for external
buttons – 1x 8A



RFSAI-62B-SL
Multifunction switch unit
with inputs for external
buttons 2-channels, 2x 8 A
(total)



RFJA-32B-SL
Switch unit for shutters,
2x 8 A

Switch units – DIN rail mounted



RFS-61M
Switch unit, 1 channel – multi-
function, 1x 16 A



RFS-66MI
Switch unit, 6 channels with
integrated antenna
– multifunction, 6x 8 A



RFS-61MI
Switch unit, 1 channel with
integrated antenna
– multifunction, 1x 16 A



RFS-66M
Switch units, 6 channels
– multifunction, 6x 8 A

Dimmers – flush mounted



RFDAC-71B-SL
Analog controller,
0(1)-10 V
– multifunction



RFDALI-32B-SL
RFDALI-04B-SL
DALI controller,
for 4/32 DALI addresses



RFDEL-71B-SL
Phase dimmer
1-channel – 1x 300 VA
– R, L, C, LED, ESL

Dimmers – DIN rail mounted



RFD-73M/RGBW
Dimmer for LED (RGB) strips,
3-channels



RFDEL-71M
Universal dimmer,
1-channel – 1x 600 VA
– R, L, C, LED, ESL



RFDEL-76M
Universal dimmer,
6-channels – 6 x 150 VA

Temperature control



RFTC-3
Glass touch thermostat for
fancoils



RFTC-4
Glass touch
battery powered



RFTC-50/G
Autonomous
temperature controller



RFTC-10/G
System temperature
controller



TC TZ
Extrenal temperature
sensors



RFATV-2
Wireless thermostatic
valve



RFTI-20
Temperature
and humidity sensor



RFSA-266M
Switch unit for
fancoil control



RFSTI-11B-SL
Switch unit
with external
temperature sensor

Converters



RFIM-40B/BP-SL
4 input contacts converter
battery powered



RFIM-40B/230-SL
4 input contacts converter
AC 230 power supply



RFSG-1M
Input contact converter
-1x permanent contact

Detectors



RFMD-200
Motion detector



RFMD-100
Motion detector
corner mounted



RFWD-100
Window/Door
detector



RFSF-100
Flood detector

System units



eLAN-RF-103
Smart RF gateway
with LAN



RFRP-20N
Repeater to extend
the range



RF Touch-2/BE
RF Touch-2/BR
Wireless touch unit
- flush mounted

Accessories



RFAF/USB
Service Key



AN-I
Internal antenna
Gain: 2.1 dBi



AN-E
External antenna
Gain: 5 dBi



AN-E3
External antenna
Gain: 3 dBi, IP67



Extension cable for external
antenna
10 m

Socket panels – metal frames



MSS3/B
Graphite black

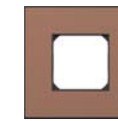

MSS3/C
Antique copper

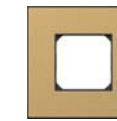

MSS3/G
Satin brass



MSS3/S
Brushed silver

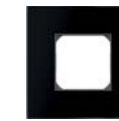

GSS3-B
Black glass



GSS3-W
White glass

Socket panels – glass frames

Accessories



VM55SB-U
Multistandard socket
2-modules



EM68SB-U
USB A+C
1-module



KM35SB-U
HDMI
1-module



KM39SB-U+
KM50SB-U
LAN
1-module



EM31SB-U
PIR
1-module



TM21SB-U
Blind cover
1-module



VM55SW-U
Multistandard socket
2-modules



EM68PW-U
USB A+C
1-module



KM35PW-U
HDMI
1-module



KM39PW-U+
KM50PW-U
LAN
1-module



EM31PW-U
PIR
1-module



TM21PW-U
Blind cover
1-module



- 1** Infront of door hotel room unit
RFBS-30/S, 24V/230V powered

- 2** Glass touch controller with symbols and two outputs
RFSW-62/S, 24V/230V powered

- 3** Glass touch thermostat for fancoils
RFTC-4, battery powered, controll RFSA-266 M

- 4** Motion detector for ceiling mounting
RFMD-200, battery powered

- 5** Window/door detector
RFWD-100, battery powered

- 6** Glass touch controller, 4 buttons
RFGB-40, battery powered

- 7** DALI controller, 4 DALI ballast
RFDALI-04/B-SL, 230V powered

- 8** Switch unit for fancoil control
RFS-266M

- 9** USB/LAN socket panel
GSS3-USB/LAN

- 10** AC power multistandard socket
GSS3-PMS

Isla Mallorca

Mallorca, Spain



- 4-star hotel in Palma de Mallorca
- 10 floors, 154 rooms, wellness, bars, restaurant, meeting rooms
- lighting control, HVAC control
- exit button (switch OFF)

Radisson Blu Ridzene Hotel

Riga, Latvia



- 7 lighting zones integrated in iNELS RF system
- sockets near beds for comfortable staying
- switches with laser-printed icons

Wyndham Grand

Istanbul, Turkey

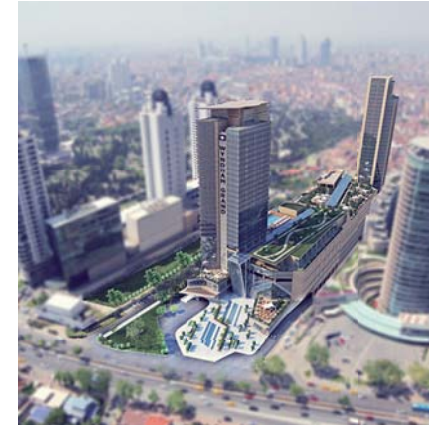

- lighting control in each room, the common areas, conference rooms and other spaces
- 3000 lighting circuits are controlled through the DALI protocol
- EMDC units

Meydan

Dubai, UAE



- lighting control
- crystal chandelier
- starry night sky control
- audio/video system

Marriott Marquis

Doha, Qatar



- 5-star hotel in the Doha City center
- 44 floors, 397 rooms, 182 suites,
- 18 meeting rooms
- lighting control
- HVAC control
- master switch OFF

Rocks Hotel & Casino

Kyrenia, Cyprus



- 5-star hotel located close to historical city Kyrenia
- the lights are controlled in iNELS system via light panel
- USB socket, glass thermostats

Movenpick

Dubai, UAE



- 255 rooms, 230000 sq,
- 530 units, 1600 light circuits
- control appliances, lights
- HVAC control
- garage doors, sockets

Merit Royal Premium

Kyrenia, Cyprus



- 125 rooms
- complete management of hotel rooms
- scenes: arrival/departure and day/night
- Guest Room Hotel Management System

Hotel Claude Marbella

Marbella, Spain



- modernization of 7 luxury rooms
- room scenes, automatic lighting
- controlling by using glass readers and card holders

Authorized Distributor in Saudi Arabia



**SMART
FINGER**
Your Smart Choice in IT Solution

Mobile: +966 56 997 2277 / Email- info@smart-finger.com

Al Rosais Tower, Olaya Street, Olaya Computer Market, Saudi Arabia